

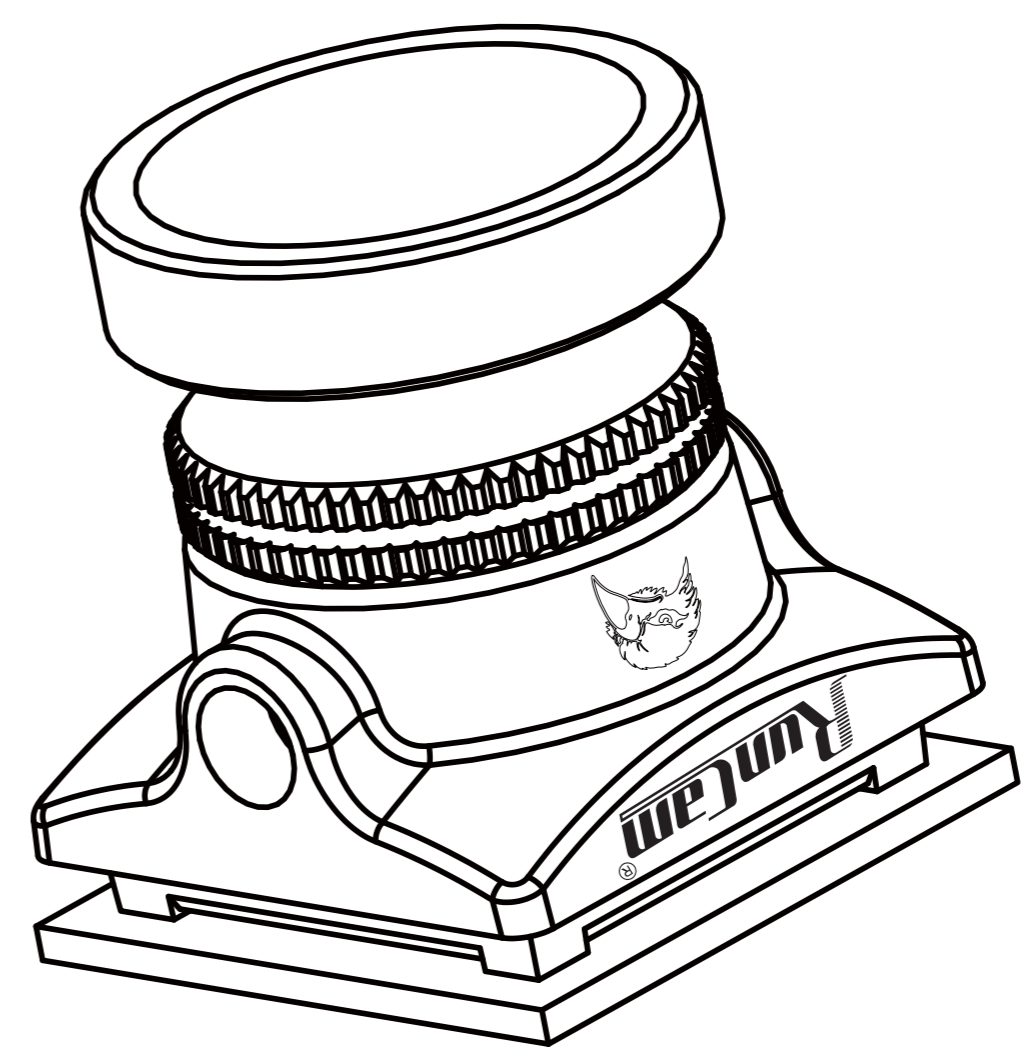

RUNCAM MICRO EAGLE USER MANUAL



Connection

* Unplug the 5D-OSD menu cable after OSD setting.

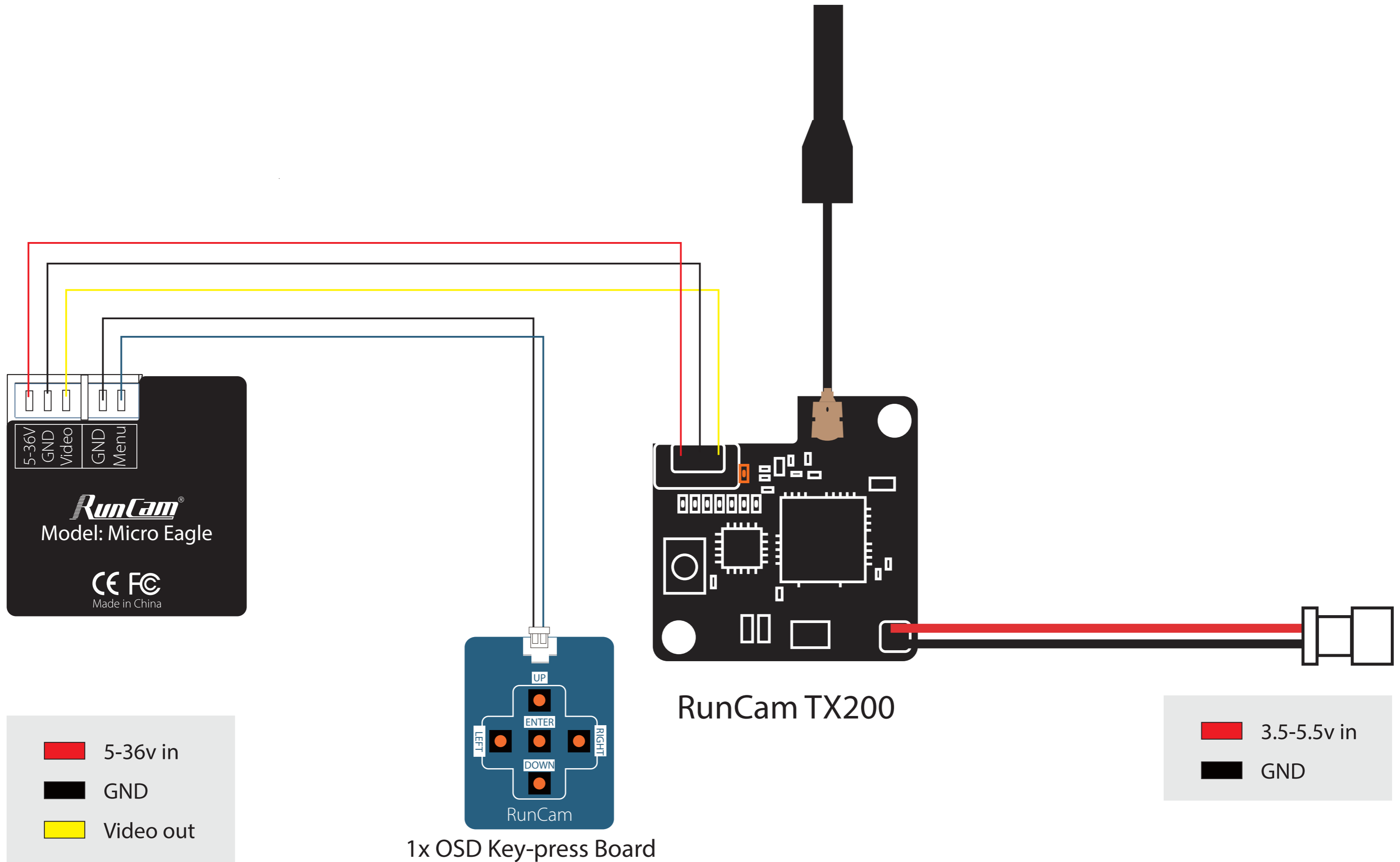

Dimensions

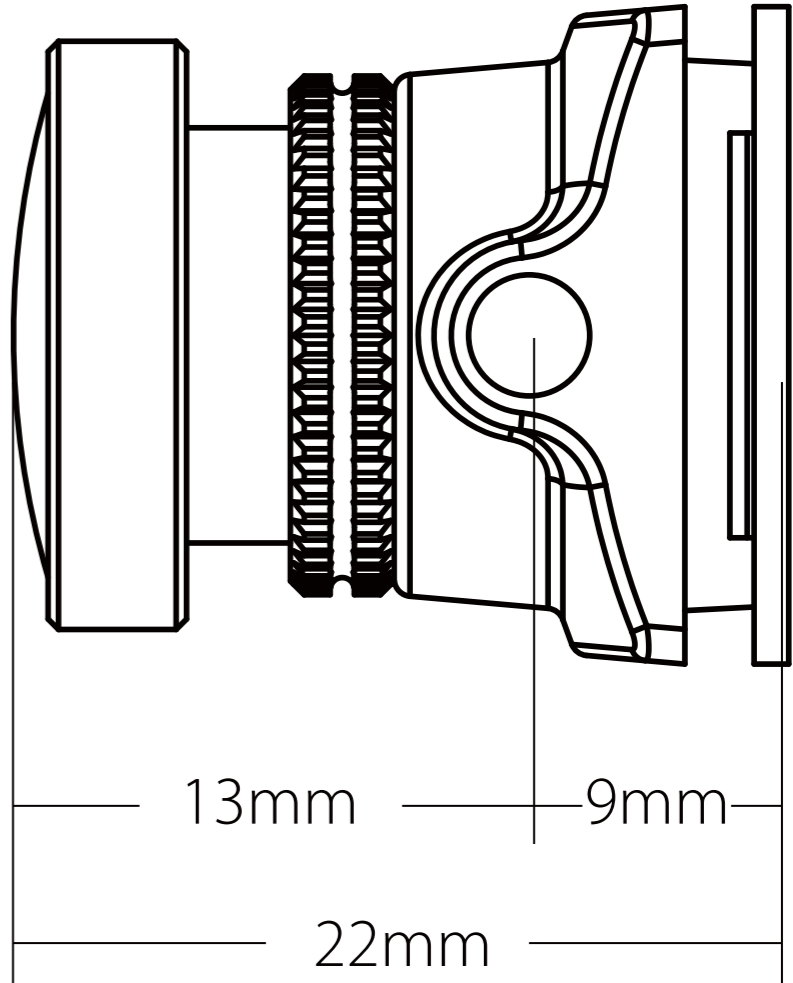
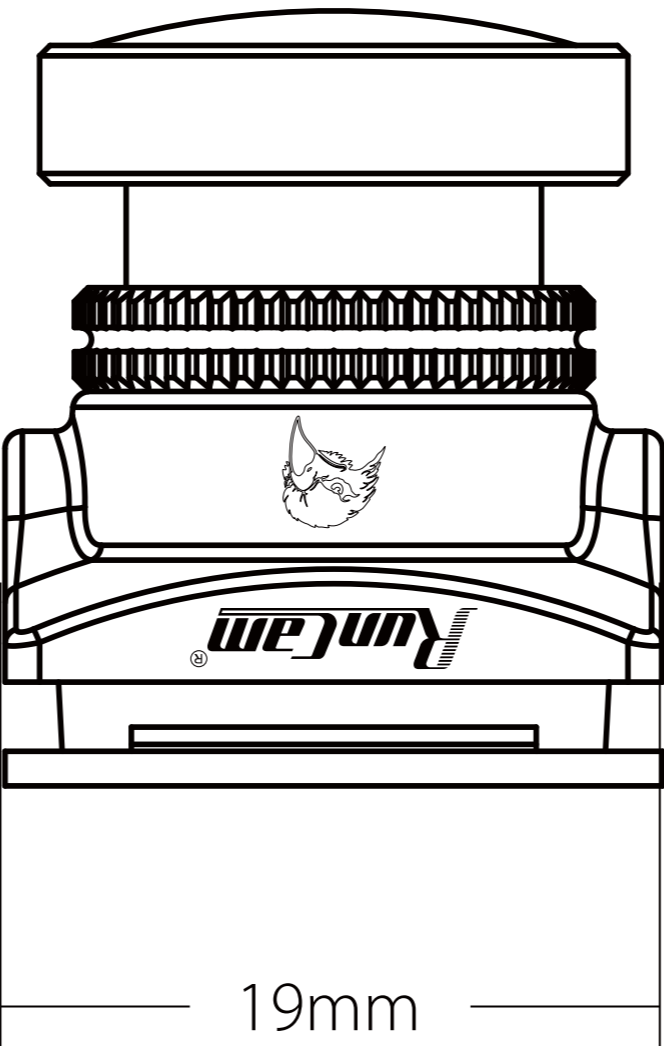
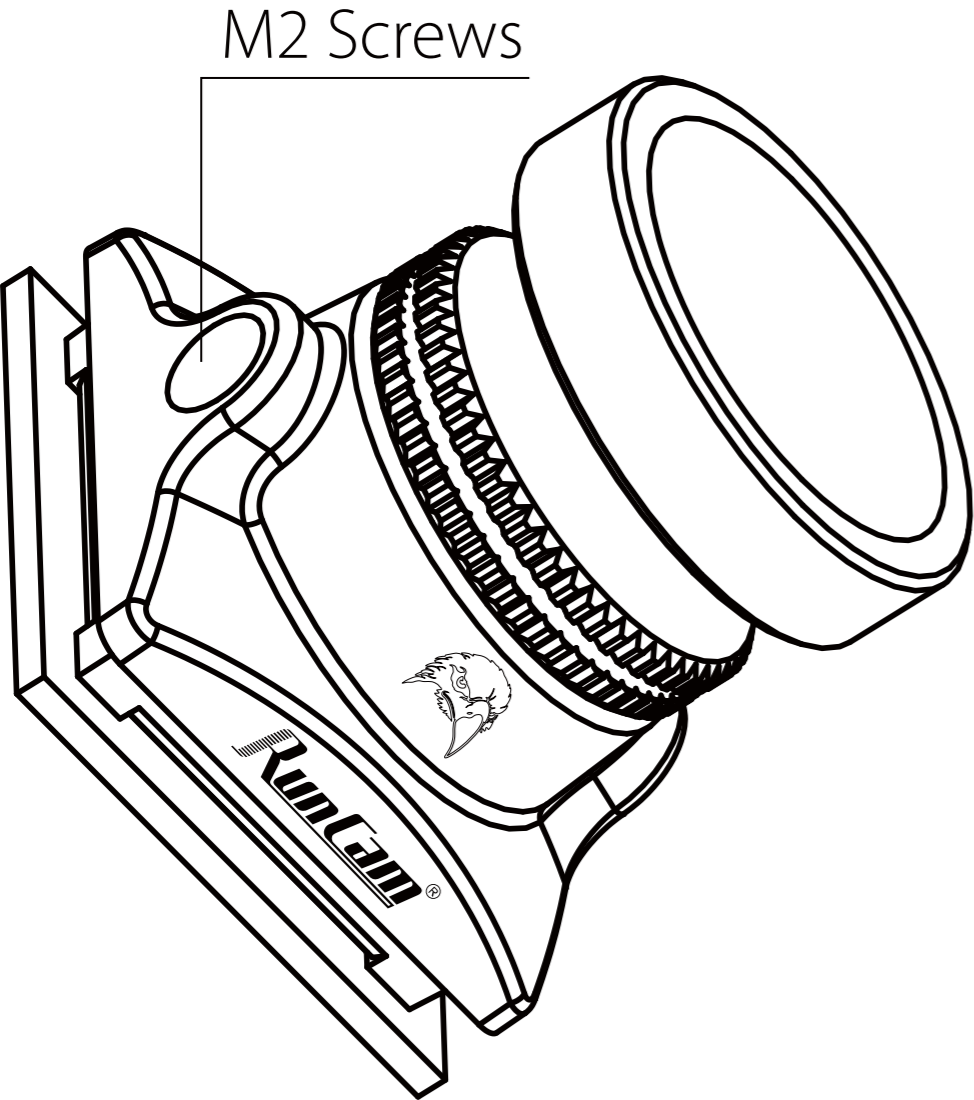
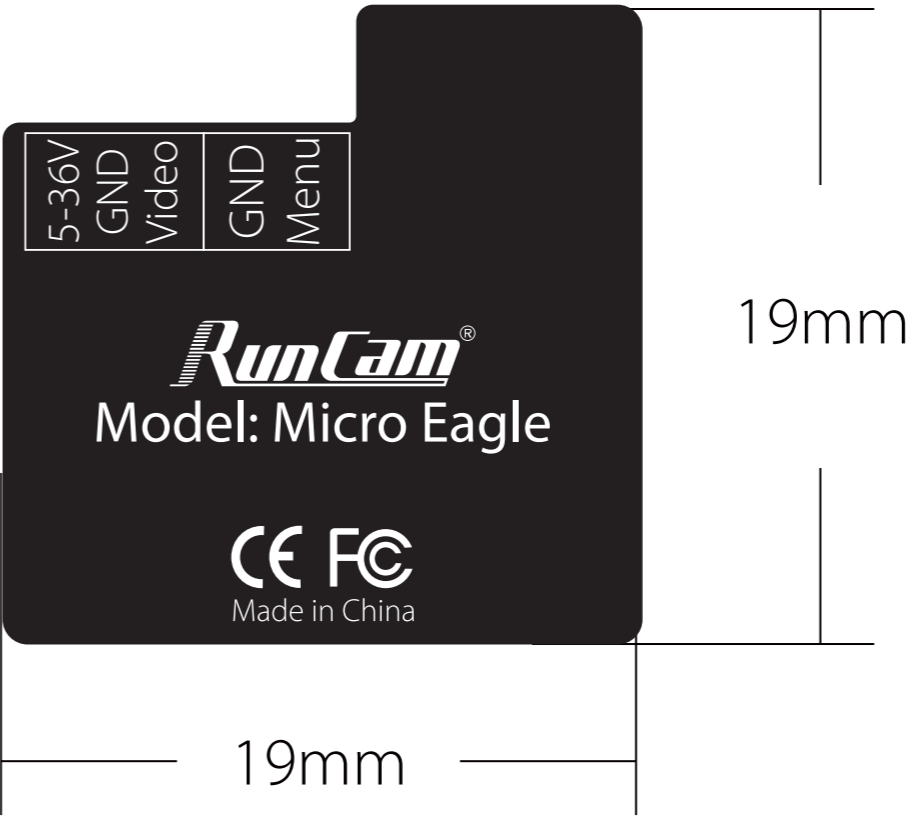
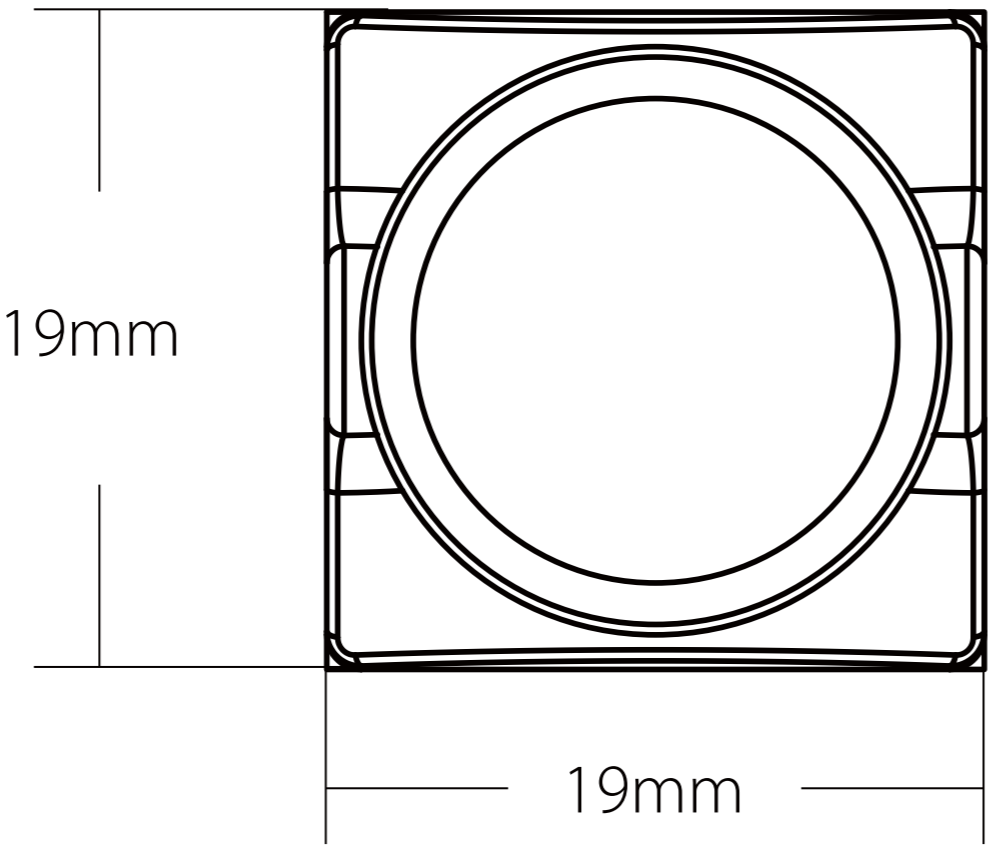

Camera Menu

MAINMENU

IMAGE	←
DAY&NIGHT	Color
VIDEO STANDARD	PAL-50HZ
SCREEN FORMAT	4-3
LANGUAGE	ENGLISH
LOAD DEFAULT	
SOFT VERSION	
SAVE&EXIT	
EXIT	

IMAGE

MAX GAIN	7
WDR	5
IMAGE ENHANCE	←
MIRROR	OFF
FLIP	OFF
BRIGHTNESS	36
ZOOM IN	0
RETURN	←

- DAY&NIGHT (Color/B&W/Auto/External)
- VIDEO STANDARD (PAL-50Hz/NTSC-60Hz)
- SCREEN FORMAT (4-3/16-9)
- LANGUAGE (English/中文)
- MAX GAIN (7 / 1-9)
- WDR (5 / 1-6)
- MIRROR (OFF/ON)
- FLIP (OFF/ON)
- BRIGHTNESS (36 / 8-250)
- ZOOM IN (0 / 0-5)

Camera Menu

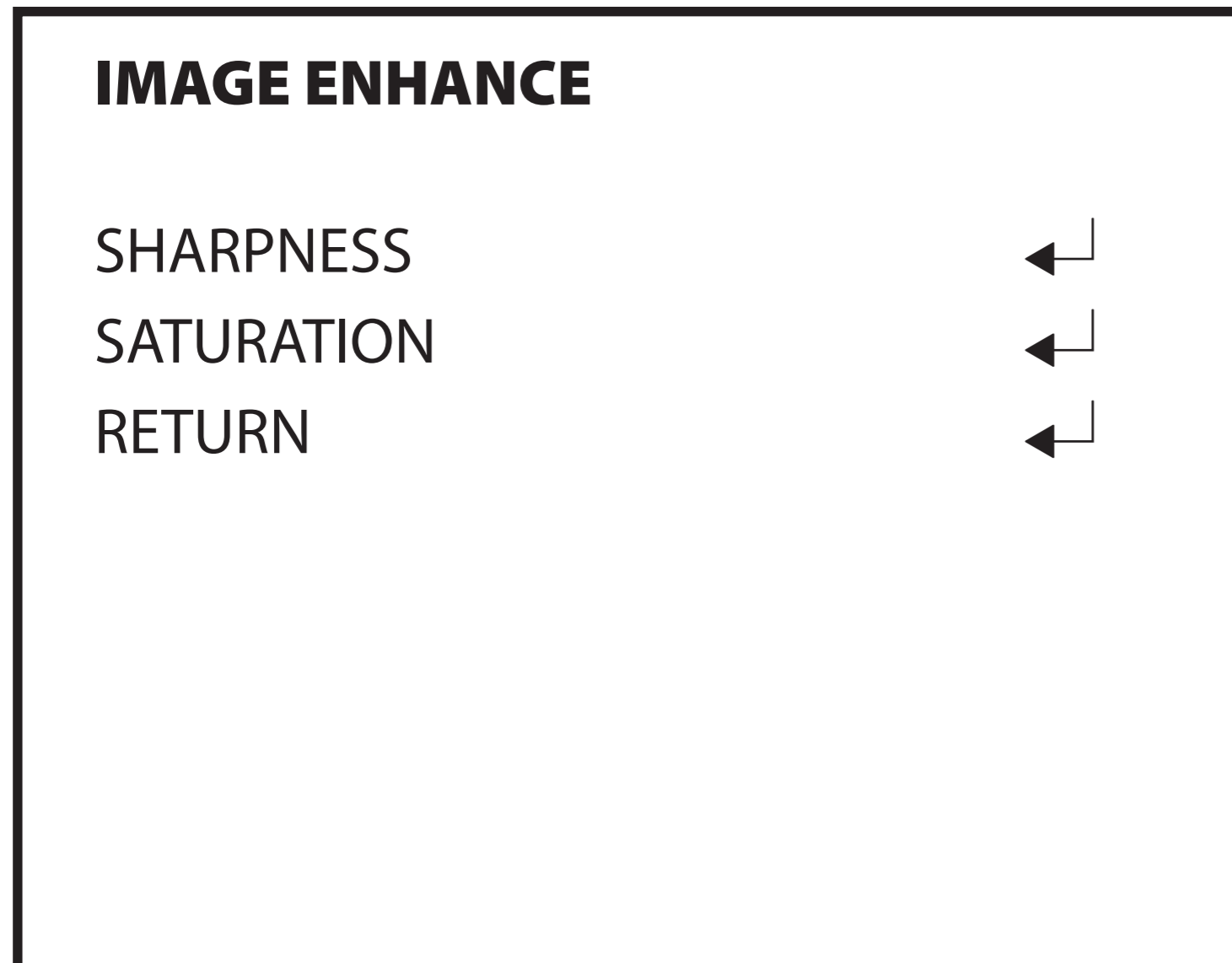

- SHARPNESS (DETAIL / EDGE)
- SATURATION (AUTO/MANUAL: 0-15)

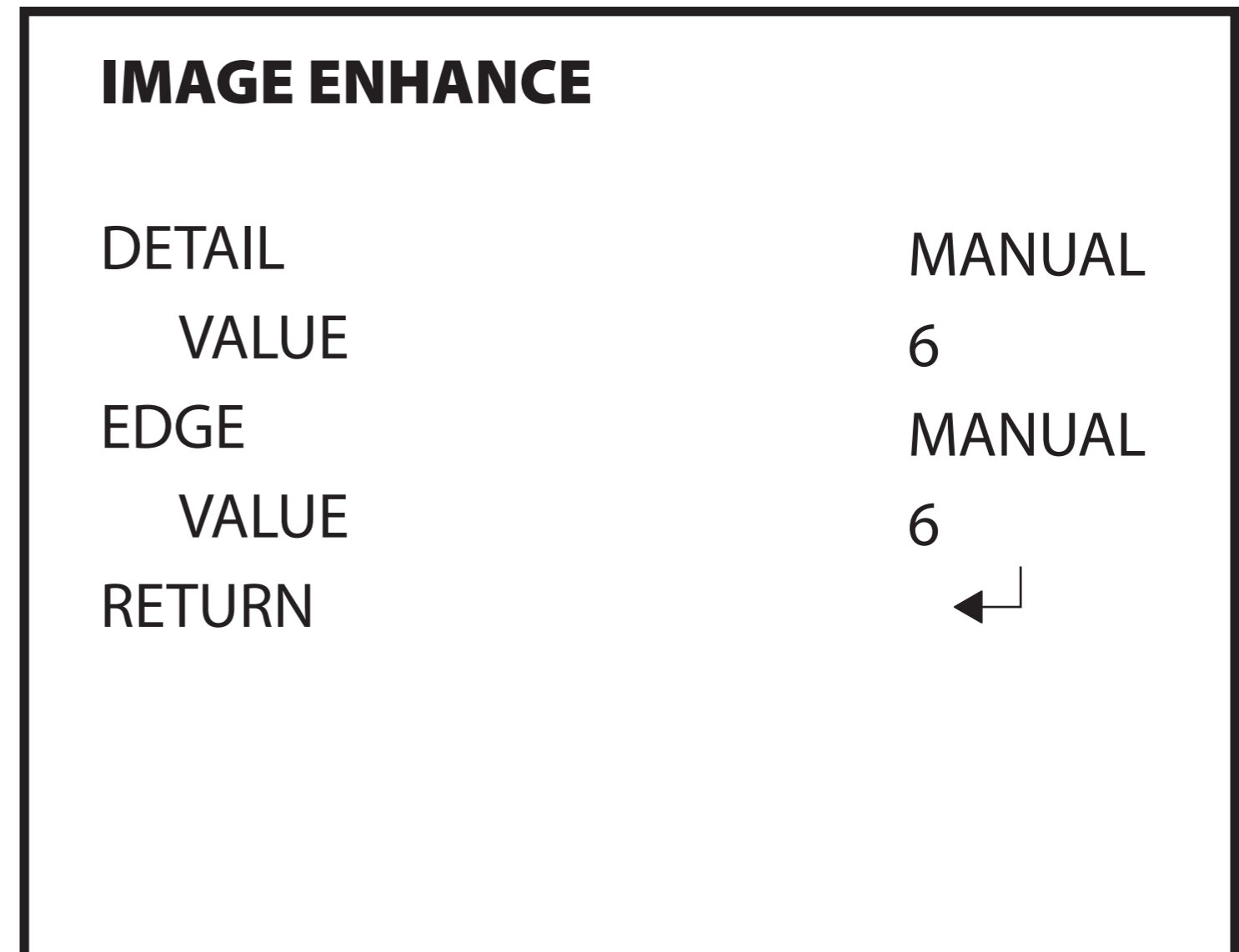

- DETAIL (MANUAL: 0-15 / AUTO)
- EDGE (MANUAL: 0-15 / AUTO)

Parameters

Model	RunCam Micro Eagle	
Image Sensor	1/1.8" CMOS Sensor	
Horizontal Resolution	800TVL	
FOV	FOV 170 @ 16:9	FOV 140 @ 4:3
Screen Format	16:9 / 4:3 Switchable on OSD menu	
Signal System	NTSC / PAL Switchable on OSD menu	
Mirror/Flip	Yes	
S/N Ratio	>50dB	
Electronic Shutter Speed	Auto	
Max Gain	1-9 Level	
Min. Illumination	0.001Lux@1.2F	
WDR	Global WDR 1-6 Level	
Day/Night	Auto / External / Color / B&W	
Power	DC 5-36V	
Current	200mA@5V / 90mA@12V	
Housing Material	ABS	
Net Weight	8.5g	
Dimensions	L19mm*W19mm*H22mm	

www.runcam.com